

## INSTALLATION- and OPERATING INSTRUCTIONS



Safety  
through  
Technology

Edition 05/2002  
Order No.: EA 4.3  
● / USA / 5 / R

Patents granted in  
Patente wurden erteilt in

DE	3 735 077
GB	2 211 070
I	1 207 344
USA	4 854 608

**Important! Read carefully.**

<b>Installation and Operating Instructions</b>	01 - 29
Questions about Installation	01 - 04
How the Schroth asm-autocontrol works	05
Package Contents	06
Installation	07 - 22
Operating	22 - 28
Care and Maintenance	28 - 31
<b>Troubleshooting Diagrams (TSD)</b>	32 - 36
<b>Accessories and Spare Parts</b>	37
<b>Certified Vehicle List</b> (Vehicle Reference List)	yellow page



This manual contains important information as well as **DANGERS**, **WARNINGS** and **SAFETY INSTRUCTIONS** regarding the proper installation, effective use and maintenance of the SCHROTH harnessbelt. Please be sure to read and thoroughly understand its contents before beginning installation and before using the system. Follow all instructions and Safety Instructions carefully and be especially sure to heed all Dangers and Warnings.

Always keep this manual in your car for reference and be sure to leave it with the car if you sell it with the harness belt system installed.

Important information and instructions in this manual are shown:

## **DANGER**

**DANGER** deals with important points about installation of the SCHROTH harnessbelt. Ignoring these warnings will create serious danger which can lead to serious personal injury or death.

## **WARNING**

**WARNINGS** deal with important issues about installation, use, misuse or modification of the SCHROTH harnessbelt.

Ignoring these Warnings will significantly reduce the performance of the harness belt system. This can result in serious personal injury or death during an accident.

## **SAFETY INSTRUCTIONS**

- Safety Instructions contain important hints to help you effectively install, use and maintain the SCHROTH harnessbelt.

*Always carefully read and follow the information in this manual, especially those highlighted as above.*

If you cannot pull out webbing from the retractor or if the retractor appears permanently blocked –  
Is the ignition switched on?  
Refer to Troubleshooting Diagram 5  
[TSD 5] on page 36.

# SCHROTH®

## INSTALLATION- and OPERATING INSTRUCTIONS

Approvals asm-autocontrol

USA:

Tested in accordance with applicable provisions of FMVSS 209

Other Countries:

Rallye 3 A

Approval-Number: Ser 4m  040396

Made in Germany

Made in Germany by:

**SCHROTH Safety Products GmbH**

Postfach 24 40

59714 ARNSBERG

GERMANY

Phone + 49 - 29 32 - 97 42-0

Fax + 49 - 29 32 - 97 42-42

Imported by:

USA: **MDI Inc.**

3 First Avenue

Peabody, MA 01960

Phone (800) 884-BELT

Other Countries: see

[www.schroth.com](http://www.schroth.com)

**Congratulations!**

With the purchase of this SCHROTH asm harnessbelt, you have chosen a sophisticated restraint system, which represents a further advance in harness restraint technology. Extensive research, testing and field experience has shown it to offer, when properly installed and worn, high levels of protection in head-on collisions.

SCHROTH asm-autocontrol harnessbelt systems with the emergency locking retractor are only intended for installation at the left and right outboard front seating positions of passenger cars which have been specifically evaluated by SCHROTH engineers for anchor point locations and suitability of available front seats.

Before attempting installation, please first answer the following questions and carefully follow the instructions which accompany them.

## **WARNING**

Restraint systems can only offer protection if they are properly installed and used.

To assure proper function, your car must meet special technical requirements.

Before installation of SCHROTH harnessbelt, please answer a few very important questions to make sure the SCHROTH harnessbelt system can be properly installed and effectively used in your car.

1. Is your vehicle listed in the Certified Vehicle List (Vehicle Reference List)?

Compare your car's specifications to the Make, Type No. and Model Year of vehicle in the Certified Vehicle List (Vehicle Reference List).

YES  NO

## WARNING

Proper harness belt geometry requires that seat belt anchor points be located within narrowly defined areas. Therefore SCHROTH harnessbelts may only be installed in SCHROTH approved vehicles for which proper anchorage location and belt geometry has been determined to exist.

2. Are there openings between the backrest and the headrest of the seat? (See illustration below.)

YES  NO

## WARNING

Harness belt system will not function properly and must not be installed in vehicles equipped with seats having no headrest or backrests with integrated headrest. (No openings exist between the backrest and the headrest.) Never create a new opening in the seats installed in your car.



3. If you intend to install the tail straps of the SCHROTH harnessbelt system at the rear seat lap belt anchor point
- have you made sure that the Certified Vehicle List (Vehicle Reference List) allows or requires you to do so?

YES  NO

- is your vehicle equipped with a SCHROTH approved seat? [see Certified Vehicle List (Vehicle Reference List) and Legend on yellow pages]

YES  NO

## WARNING

Installation to anchor points located lower than the front seat backrest with an unapproved seat can result in serious personal injury or death. Never install the SCHROTH harnessbelt at these lower anchor points unless this installation is allowed for your vehicle's make, model and model year and it is used with an approved seat. [See Certified Vehicle List (Vehicle Reference List) and heed all indexes.]

4. Do you have a left belt for the driver's side and/or a right belt for the passenger's side? (See illustrations on page 7.)

YES  NO

## WARNING

Left and right belts are not interchangeable! Installation of harness belts on wrong side of vehicle can cause severe head injury or death during rebound phase of frontal collision! Make sure the black asm-cartridge is on inboard strap - see illustrations on page 7.

5. For certain vehicles special mounting accessories are required. [See Certified Vehicle List (Vehicle Reference List).]

If required for your vehicle: do you now have them available for installation?

YES  NO

If you answer any question with [NO], do not install the SCHROTH harnessbelt system.

Do not install the SCHROTH system in your car unless it is possible to make SCHROTH approved modifications which allow you to answer all questions with [YES].

If you have answered **ALL** questions with [YES], you may install the SCHROTH harnessbelt system in your car.

Please remember that installation procedures will require you to perform a variety of operations requiring familiarity with tools and mechanical procedures. If you have any doubt about your ability to properly install the SCHROTH asm harnessbelt system, take this manual and all parts supplied to a competent mechanic for installation.

# WARNING

Please follow these instructions carefully while installing and before using the belt! Failure to follow instructions can not only damage and reduce the performance of the system, but may also result in the denial of warranty claims.

# SAFETY INSTRUCTIONS

- SCHROTH asm harnessbelts are designed to be installed in addition to the stock restraint systems. Always heed Country/State laws governing the wearing of seat belts.

# WARNING

Be sure that the tail strap of the harness belt is not interfered with or misdirected by cargo or by folding rear seat.

This SCHROTH asm harnessbelt is only suitable for adults on front outboard seating positions.

SCHROTH asm harnessbelts are not intended or suited for use by children under 12 years of age, or persons who weigh less than 88 lbs (40 kg) or those who are less than 4'11" tall (1,50 meters), regardless of age. Such persons will not be adequately protected by the harness system and may receive more severe injury than would otherwise be expected.

SCHROTH U.S. model harnessbelts have been tested in accordance with performance parameters of Federal Motor Vehicle Safety Standard 209 with the exception of Paragraph S 4.6 (full scale impact testing as described in FMVSS 208). FMVSS 209 deals with lap and three point restraints and does not expressly refer to harness belts. SCHROTH has nevertheless applied the performance criteria specified in FMVSS 209 to the system to the extent applicable.

These belts, when properly installed and used according to applicable instructions can mitigate injury. The ability of any restraint system to mitigate or prevent injury is directly related to the type and severity of the accident. SCHROTH asm harnessbelts have been tested in dynamic sled tests utilizing a 75 kg (165 lbs) Hybrid II anthropometric dummy to simulate head-on collisions at 50 km/h (31 mph). They also have been dynamically tested utilizing a 75 kg mass dummy in accordance with European Safety Standard ECE-R 16.04.

# SAFETY INSTRUCTIONS

- Always keep this manual in the vehicle so that others can thoroughly familiarize themselves with the proper use of the system.

## How the SCHROTH asm-autocontrol retractor works

The SCHROTH asm-autocontrol is the first harness belt system for street use to offer the comfort, convenience and safety of an automatic retractor. The SCHROTH asm-autocontrol gives you greater freedom of movement to reach vehicle controls while providing the benefits of a harness system. The heart of the SCHROTH asm-autocontrol harnessbelt is an electro-magnetically operated emergency locking retractor.

The retractor is both, webbing and vehicle sensitive. It will lock when belt webbing is unreeled too fast. It will also lock when forces act on the vehicle from any direction during an accident or during extreme driving maneuvers such as heavy braking or during sharp cornering. The retractor will also lock if the vehicle is tilted more than 25 degrees.

A sensor controls the electro-magnetic operation of the retractor. In order to work properly and react to forces coming from different directions, the sensor must be installed vertically. If the sensor is not installed vertically, the retractor will be more sensitive to forces applied to the vehicle from one direction than from another and the system will not work properly. The retractor will unlock allowing webbing to be unreeled and you to move as soon as current flows to the electric-magnetic system in the retractor from your car's 12 volt electrical system. Electrical current flows whenever the ignition is switched on.

When forces act on the vehicle that trigger the sensor, the flow of current to the electro-magnetic system of the retractor is interrupted and the retractor locks. Webbing can no longer be let out, but the retractor is still able to take up slack in the webbing.

For your safety, the system was designed to lock up whenever the flow of current to the retractor is interrupted. For that reason the retractor is locked when the ignition is turned off.

The correct sequence for buckling the SCHROTH asm-autocontrol harnessbelt is always:

1. after making sure that the transmission is in Park or Neutral with the hand brake firmly engaged,
2. switch ignition on, but do **not** start engine,
3. buckle up,
4. only then, start the engine.

By following this procedure you will be able to prevent your car from moving when you do not want it to while you are putting on the harness belt.

## PACKAGE CONTENTS

### international version

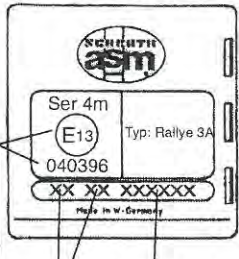

Prod.-Number

Date of manufacture  
(week/year)

certification number  
(ECE-R16)

### US version

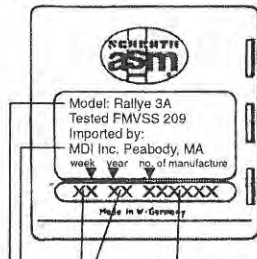

Prod.-Number

Date of manufacture  
(week/year)

Importer

Type of belt

## Installation hardware

### for harness belt

Bracket for C-pillar mounting	1x
Bolt 7/16", length 1 1/2"	1x
Bolt 7/16", length 1"	2x
Bolt 7/16", length 3/4"	1x
Washer	1x
Spacer sleeve	1x
Spring washer	4x
Hexagon nut 7/16"	1x
Cover for bolt head	2x
Cover for hex nut	1x
Transparent Sticker (indoor)	1x
SCHROTH asm sticker	1x

### for sensor

Perforated metal strip	1x
Sheet metal screw	2x
Hex bolt 4 mm	2x
Spring washer 4 mm	2x
Hexagon nut 4 mm	2x
Fuse 5 Ampère (blade type)	1x
Fuse wire (red/blue, with 2 connectors)	1x
Main wire (red/blue)	1x
Cable grommet	1x
Bubble level [only USA]	1x

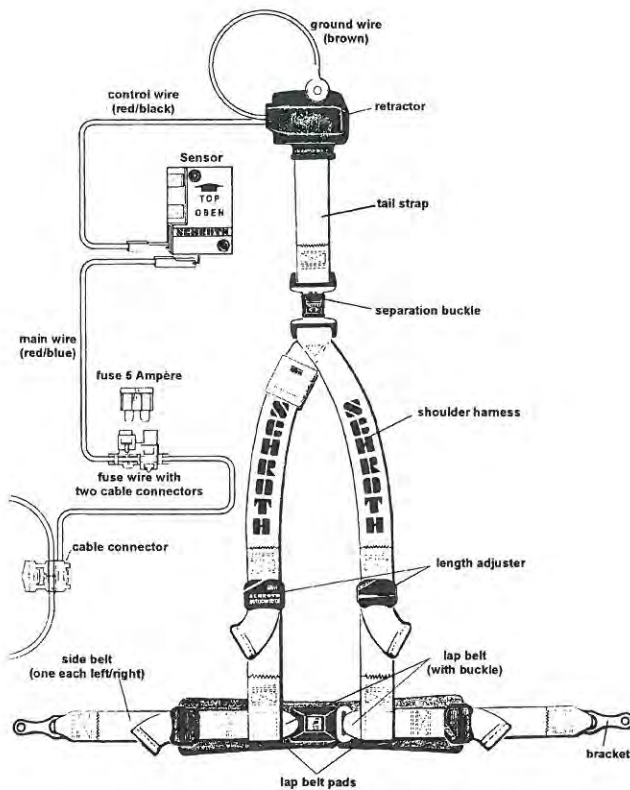

## INSTALLATION

### 1 General Instructions

Always leave original equipment seat belts in place and available for use.

We strongly recommend that you leave the standard 3-point restraint system originally supplied for the front seating positions of your vehicle as well as those systems originally installed for the rear seating positions in place when you install the SCHROTH asm harnessbelt.

Leaving original equipment systems in place and fully functional will enable you to use the vehicle's standard seat belts when it is necessary to transport passengers in any of the rear seats or when either harness belt is not suited for use by the driver or front seat passenger. Removal of equipment restraint systems may violate applicable State or Federal law.

To use the standard 3-point restraint system, release the SCHROTH asm-harnessbelt tail straps and store both the front and rear sections out of the way.

# ! WARNING

Separate SCHROTH asm harnessbelts are supplied for the left and right sides.

**Black asm cartridge must be on the inboard shoulder strap when system is installed (see illustration). Never install belt on wrong side of vehicle. System will not function properly in an accident and serious injury or death may occur.**

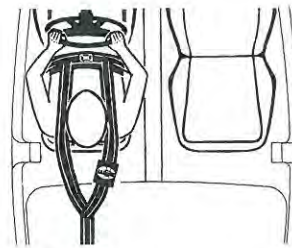

left belt

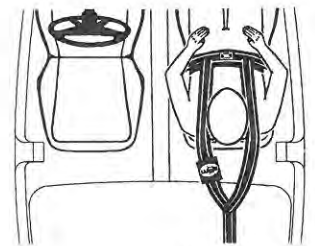

right belt

# ! WARNING

Use of improper attachment points will impair system performance.





Weak tail strap anchor points will not withstand the forces in an accident and increase the risk of personal injury in an accident.

Never attach the tail strap to anchorages intended for the tether straps of child seats which are found on the filler panels behind the rear seats of some passenger cars or the luggage area of some hatchbacks or station wagons. These anchor points are not strong enough to withstand the forces of an accident and are not intended for adult safety belts.

Harness belt systems may only be installed at suitable anchor points for seat belt systems as originally installed by the vehicle manufacturer.

For suitable anchor points for make, model and model year of your vehicle, see Certified Vehicle List (Vehicle Reference List). If in doubt, ask your dealer to show you where these anchor points are located.

These figures show the general location and suitability of seat belt anchor points installed as standard equipment in passenger cars.

-  Not suitable for attachment of an asm-autocontrol.
-  Must be used for the attachment of the lap belt portion of the harness belt.
-  Suitability for retractor anchorage of asm-autocontrol.
-  Retractor anchorage to anchor points "D" or "E" only if allowed for your vehicle's make, model and model year and it is used with an approved seat. [See Certified Vehicle List (Vehicle Reference List) and heed all indexes.]

## SIDE VIEW

Figure 1

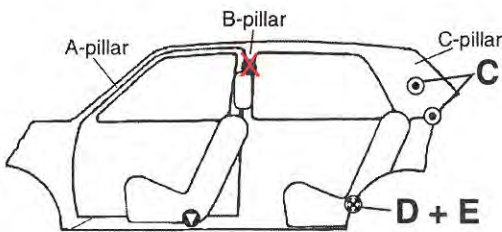

## OVERHEAD VIEW

Figure 2

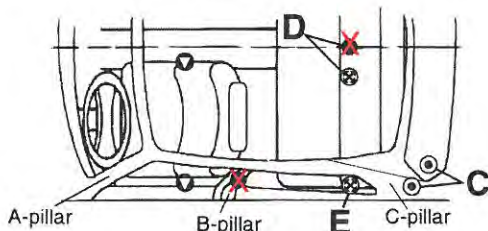

# ! DANGER

Never drill or tap or make a new attachment point in the body or chassis in order to mount a SCHROTH harness at that location. Such attachment points are inadequate, may be improperly located and can seriously impair the function and effectiveness of the system.

Please compare the possible mounting locations on your car with the illustrations on pages 9/10 and pick the one that you find most suitable.

Original equipment belts with swivel attachments must never be bent, modified, impeded or restricted in their range of motion.

## 2 Anchorage bolts

Bolts used to attach original equipment seatbelts may be used to attach the SCHROTH asm harnessbelt if they are long enough. You must be able to tighten each bolt a minimum of nine (9) full 360 degree turns. If the bolt is too short, choose one of the SCHROTH supplied bolts. (Read and observe the following Warning!)

# ! WARNING

A bolt which sticks out too far might damage the chassis, the fuel tank, fuel lines, brake lines or other important vehicle components.

Make sure enough space is available behind the thread before screwing in the 1½ inch (38 mm) long bolt.

Tightening torque for all bolts: 30 ft.lbs. (40 Nm)

## 3 Installation of the lap belt



When mounting the lap belt in a car equipped with a racing seat and integrated (non adjustable) headrests thread the belt through the openings as illustrated.

### 3.1 Re-assembling the length adjuster

# ! WARNING

We do not recommend to disassemble the length adjuster during installation process. It is not necessary to disassemble the harness belt in order to run it through the openings of racing seats.

If for any reason the length adjuster is disassembled, strictly follow the procedure step by step as described below to re-assemble the adjuster.



**Figure A:**  
Fold the strap to a loop and insert it upwards throughout the metal frame and turn the loop as indicated.

**Note:**

The strap part protruding from the adjuster for further adjustment [1] must be located above the stress taking strap [2].

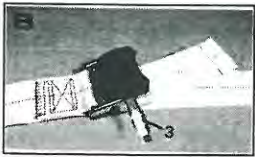

**Figure B:**  
Position the plastic cover on top of the loop and insert the metal retainer [3] through the guides of the plastic cover and the strap loop.



**Figure C:**  
Keep the metal retainer positioned between your thumb and forefinger. Slide the plastic cover backwards onto the metal frame as indicated until both ratchets [4] locks with a distinct clicking sound into the detentions in the metal frame.

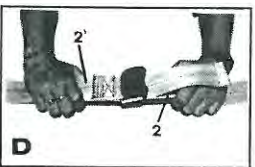

**Figure D:**  
Check by pulling both stress taking straps [2] and [2'] the adjustment device will lock safely.

### 3.2 Installation locations

at or on the center tunnel

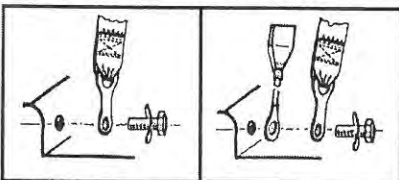

Installation without the stock belt at the seat.

Installation with the stock belt at the seat.

# ! WARNING

Damage will impair the effectiveness of the harness belt system!

Make sure that the seat and bracket are positioned so that moving parts of the seat or adjustment mechanisms cannot contact or damage the webbing of lap belt.

(See paragraph 4, Flexible range of the seat belt mounting brackets.)

at the seat

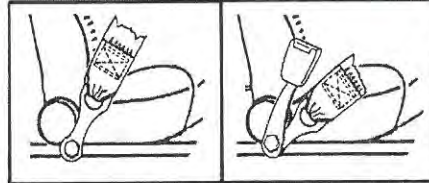

Installation without the stock belt at the seat.

Installation with the stock belt at the seat.

on the seat sliding bracket

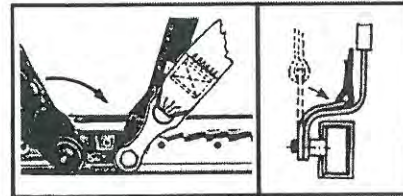

Mounting point on sliding anchor point on the seat bracket of seat with height adjustment.

Illustration shows AUDI/VW installation.

### 3.3 at the door sill

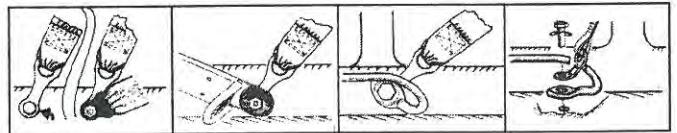

Use the foremost anchor point of the sliding bar of the stock 3-point belt.

#### 4 Flexible range of the seat belt mounting brackets

# ! WARNING

Repeated bending could weaken the bracket and cause it to fail when loaded in an accident.  
 Never bend the bracket back and forth several times.  
 Any pivoting brackets of the stock 3-point belts must not be limited in their range of motion.

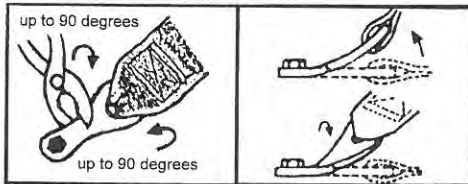

#### 5 Installation of retractor and ground wire

- anchor points are not suitable
- attachment of the lap belt portion of the harness belt
- anchor points "C" are suitable
- anchor points "D" and/or "E" are suitable only if allowed for your vehicle's make, model and model year and it is used with an approved seat [See Certified Vehicle List (Vehicle Reference List) and heed all indexes.]

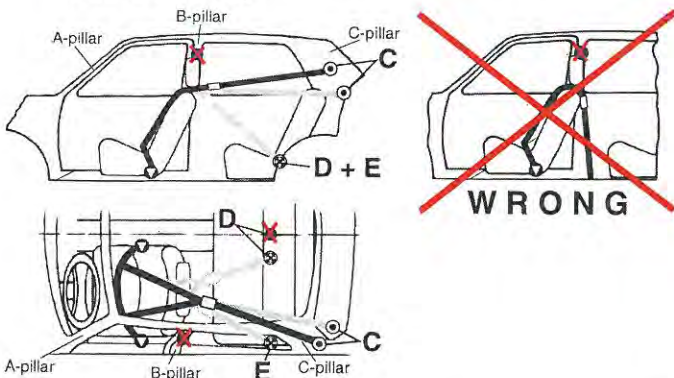

If retractor is installed at anchor point "C" (without stock 3-point belts for outboard rear seats)

If necessary open panel covering at anchor point "C" use spacer sleeve [1].

#### Bolt retractor directly to the anchor point

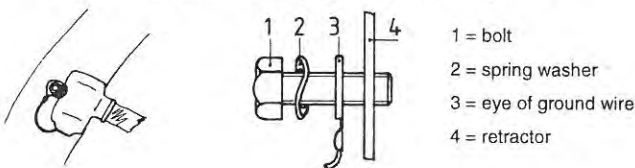

To assure a proper ground, make sure that the eye of the ground wire is located between the spring washer and retractor body (or the C-pillar mounting bracket, if used). Take care not to crack the wire when tightening.

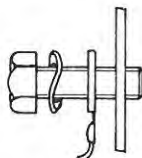

#### Installation with bracket for C-pillar mounting

Choose the positioning of the bracket depending on the installation situation as shown below.

Also select the position at the bracket for the installation of the retractor.

Heed following WARNINGS!

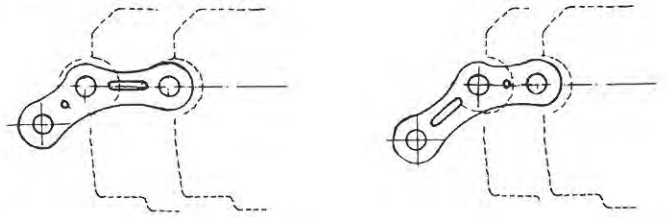

# ! WARNING

#### The retractor

1. must be installed at a sufficient distance from the stock 3-point belt swivel attachment so the range of motion of the stock belt is not restricted,
2. must be located as far as possible to the rear of the car. The retractor must be well away from the head of the rear seat passenger and the rear door,
3. must be positioned in direction of the pull of tail strap when the belt is worn (see illustration).
4. must not lay on the backrest of the rear seat, so that it cannot be positioned in direction of the tail strap webbing.

Assembly for installation of the retractor to the bracket.

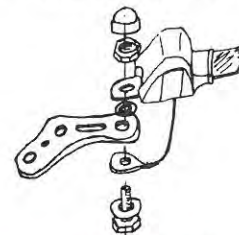

Bolt length: 3/4"

# SAFETY INSTRUCTIONS

- Depending on the design of the anchorage of the stock 3-point belt, the C-pillar mounting bracket [1] must be attached to the original assembly so that swivel attachments will not be impeded or restricted in their range of motion.

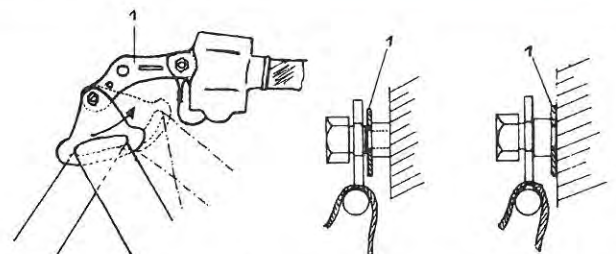

The SCHROTH bracket [1] can be carefully bend up to an angle of 45 degrees and be twisted up to 90 degrees.



# ! WARNING

Never bend the bracket back and forth several times. Repeated bending could weaken the bracket and cause it to fail when loaded in an accident.

The arrows indicate the direction of the tail strap webbing.

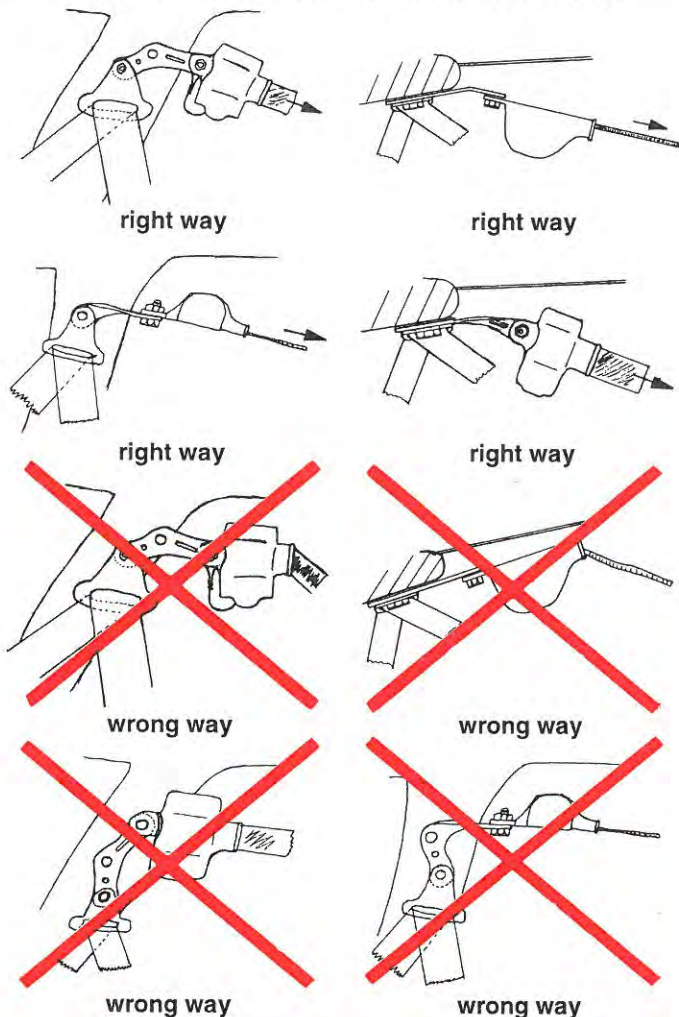

If retractor is installed at anchor point "D" or "E"

# ! WARNING

Installation to anchor points located lower than the front seat backrest with an unapproved seat can result in serious personal injury or death. Never install the SCHROTH harnessbelt at these lower anchor points unless this installation is allowed for your vehicle's make, model and model year and it is used with an approved seat. [See Certified Vehicle List (Vehicle Reference List) and heed all indexes.]

Vehicles fully equipped with rear seats and rear lap and shoulder seat belts.

For installation adapter part no. 01003 [USA: 01103] is necessary.

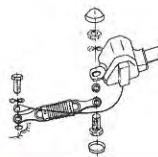
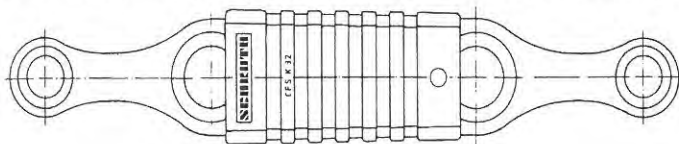

The eye of the ground wire must be fixed with the bolt at the anchor point, because the adapter is an insulator.

# ! WARNING

Align the adapter and retractor carefully before tightening the bolts to prevent twisting or kinking of the tail strap webbing and to make sure that the webbing can freely move in and out of the retractor without interference when the harness belt is in use. Webbing which is twisted or kinked or cannot move freely, can damage the webbing and will reduce the effectiveness of the harness belt system.

Vehicles with rear seats removed (competition cars).

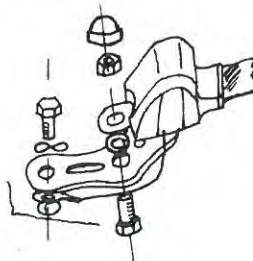

The retractor must be aligned as shown and described in paragraph 5.

## 6 Installation of the sensor

# ! WARNING

Improper sensor installation will reduce sensor performance and impair effectiveness of harness belt system in an accident.

Install sensor in a precise vertical position. During installation make sure that the car is parked on a flat, level surface.

Parking position of the vehicle for sensor installation. Make sure the vehicle is level side to side and front to rear.

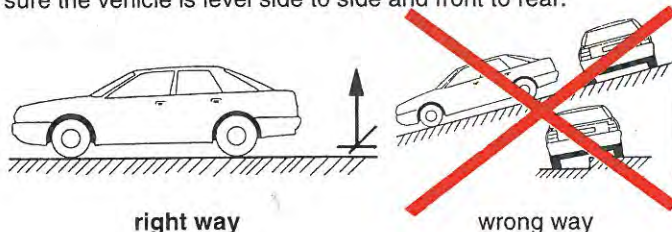

right way

wrong way

# ! WARNING

Sensor installation at an improper location can promote aging, corrosion, movement and thereby impair the effectiveness of the system in an accident. The sensor must be installed on a rigid structure which does not move and is in a protected location where it is not exposed to extreme humidity, heat or dust and cannot be unintentionally moved out of alignment.

- \* Do not install the sensor in the engine compartment (Dust, Water, Salt).
- \* Do not install the sensor in the footwell (dust and moisture from shoes).

# ! DANGER

To install the sensor, you have to drill holes for the attachment bolts! Be very careful, make sure that you do not damage the body, the fuel tank, fuel lines, brake lines or other important components! Apply the same care when tightening the attachment bolts. To prevent injury, bolts must never protrude into passenger compartment.

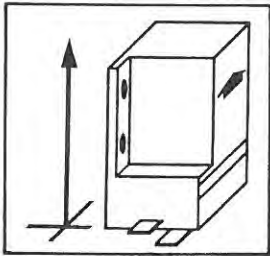

right way

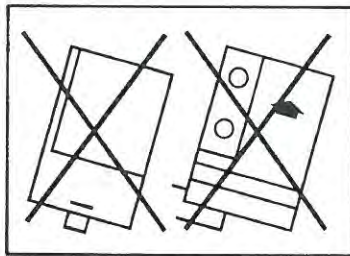

wrong way

When the sensor is properly installed in a vertical position, it will function with the same level of sensitivity locking the retractor when acted upon by sufficient deceleration from any direction.

Make sure to have enough space underneath the sensor for the electrical connections.

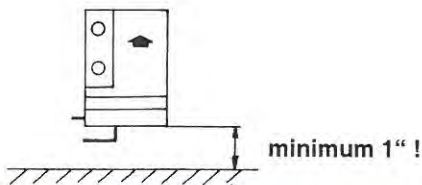

minimum 1" !

# ! WARNING

Short circuits can cause severe damage to your car and its electrical system. To avoid short circuits, connect the wires only after installation of all parts of the belt. Follow on the instructions of paragraph 7.

This figure indicates the most suitable positions for the sensor. The figure shows a car body with interior panels removed.

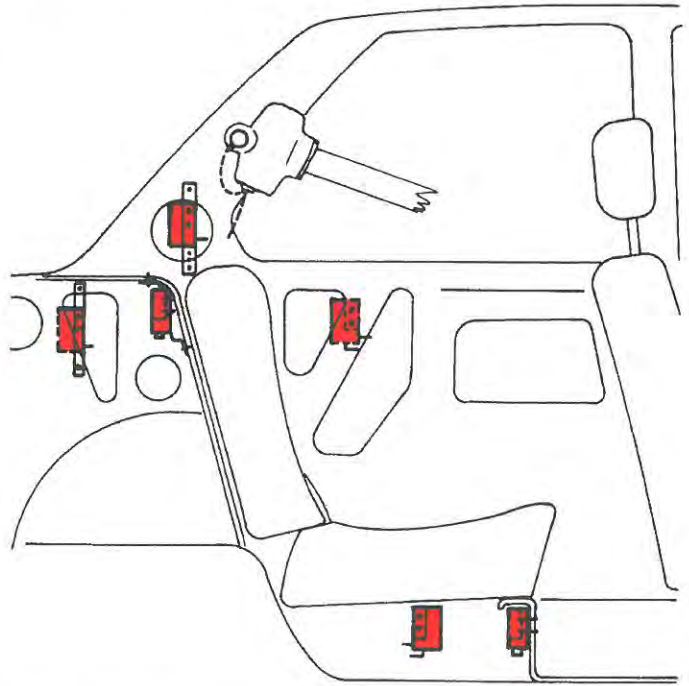

Installation of sensor directly to a rigid vertical structure of the car body which does not move.

The mounting holes must be in a straight vertical line and  $25/32"$  (20 mm) apart. Drill the upper hole first to locate the sensor in the desired position. Place the bubble level supplied on the top surface of the sensor to check the front/rear and side to side position. Mark the position for the second hole, drill and remount the sensor. Recheck the position to make sure the sensor is leveled.

for self tapping sheet metal screws, drill holes  $5/64"$  (2 mm).

for 4 mm bolts, drill holes  $13/64"$  (5 mm)

You can use sensor housing as a stencil.

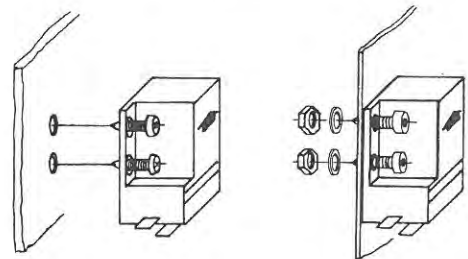

Installation with the perforated metal strip

The perforated metal strip can be carefully bent and formed as necessary for vertical installation of the sensor. Make sure that both ends of the strap are fixed by screws for permanent and rigid installation of the sensor on a non-moving structure.

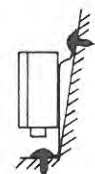

right way



wrong way

Attach the sensor to the perforated metal strip.

Attachment of the sensor to the strip

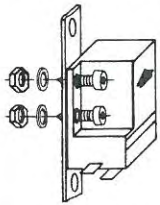

- |                     |          |
|---------------------|----------|
|                     | quantity |
| Hex bolt, 4 mm      | 2        |
| Spring washer, 4 mm | 2        |
| Hexagon nut, 4 mm   | 2        |

Drill a hole in the structure and secure the upper end of the strip. Place the supplied level on the top surface of the sensor to check the front/rear and side to side position of the sensor. Mark the position of the second hole, drill and secure the lower end of the strip.

examples for installation

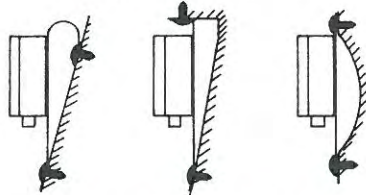

Do not bend the strip back and forth more times than necessary.

Recheck the position to make sure the sensor is leveled.

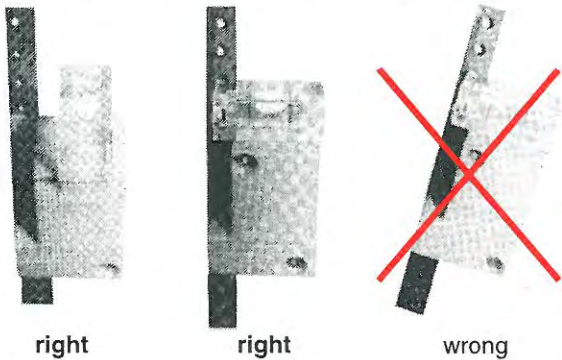

## 7 Wiring

### 7.1 Wiring diagram

R/BI	RED/BLUE	Main wire
R/S	RED/BLACK	Control wire
B	BROWN	Ground wire

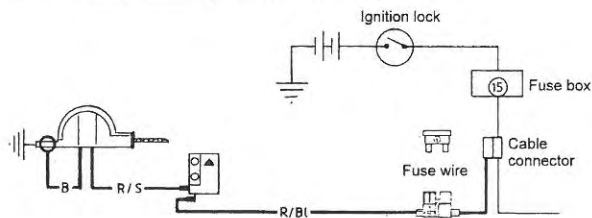

### 7.2 Connection from the retractor to the sensor

Run the control wire (red/black) from the retractor to the sensor so that the wire does not protrude into the passenger compartment and cannot be snagged by the driver or a passenger and cannot be damaged by cargo, by sharp sheet metal edges or other objects. If the wire is too long, carefully stow excess wire close to the sensor.

Be careful when folding rear seats so that their function is not restricted and the wire cannot be damaged.

If you must drill a hole to lead the wire through an interior panel be sure to heed the following DANGER and carefully follow the applicable instructions.

## Vehicle Reference List SCHROTH asm-autocontrol

Make Model	Model No.	Mod. Year	install retractor to anchor point	
			C	D <sup>Y</sup>
<b>AUDI</b>				
4000	81	80-87	+	-
5000	43	80-83	+	-
Coupé, GT	85	82-87	+	-
<b>BMW</b>				
1602-2002, not convertible		68-76	+	-
3-series	E21	77-83	+	-
3-series		86-91		
-sedan				
Mod.-No.: AB54/64, AE54/64, AD23, AA23, AB03, AB93, AE03, AF93, AJ93			+	-
w/uncovered anchor point C			+	-
5-series	E12	72-77	+	-
	DK73, DK83,	82-88	+	-
	DC74, DC84			
-M5	DC93	82-88	+	-
6-series	EC74, EC84	76-89	+	-
-M6	EE14	76-89	+	-
7-series	FH74, FG24	78-86	+	-
w/uncovered anchor point C			+	-
<b>DAIHATSU</b>				
Rocky	FF31, FF32	90-	+	-
<b>GEO</b>				
Metro	MS2, MR2	89-94	+	-
Tracker	E18, J18	89-		
seat with integrated headrest			S	-
seat without integrated headrest			+	-
<b>HONDA</b>				
Civic Coupé, only 2-door	EJ222, EJ122	93-	+	-
<b>JEEP CHRYSLER</b>				
Wrangler 17)	Y19, Y29	92-	S	-
<b>MAZDA</b>				
323	BF22, BF23	87-89	+	-
929	HC22	88-91	+	-
<b>MITSUBISHI</b>				
Cordia	F34,F44,F54,F64	83-87	+	-
<b>NISSAN</b>				
Sentra, only Coupé	B24	87-90	+	-
200 SX, only hatchback	S26	-88	+	-
Stanza	T21, T23	86-89	+	-
Maxima	U11	86-89	+	-
Pathfinder	D14,D16,D17	87-	+	-
<b>RENAULT</b>				
R5, LeCar		76-83	+	-
<b>SUBARU</b>				
Justy, only 2-door	A72, A73, A83	87-	+	-
<b>SUZUKI</b>				
Suzuki Swift, only 2-door	AC	90-94	+	-
Suzuki Sidekick, only with short wheelbase	TC,TA,TD	89-	+	-
<b>TOYOTA</b>				
Starlet, only version without rear side vent window		81-84	+	-
Corolla	E82E, E83E, E84E	-87	+	-
Celica, not convertible				
Mod.-No.: T63C-T67C, T64L-T67L, T68M		86-89	+	-
Camry		87-91	+	-
Landcruiser, only with short and middle wheelbase		85-	+	-
4-Runner, only 5-door	N27V,N37W	89-	+	-
<b>VOLKSWAGEN</b>				
Beetle	11	60-79	+	-
New Beetle 27), 35)		98-02	+	-
Rabbit	17	75-84	+	-
Jetta I		80-84	+	-
Scirocco I	53	75-81	+	-
Golf	17, 1G	85-92	+	-
Jetta II	16, 1G	85-92	+	-
Golf IV, 2-door 27), 35)	9B	02-	+	-
Jetta 27)	9M	02-	+	-
Scirocco II	53	82-88	+	-
Corrado	50	90-95	+	-
<b>VOLVO</b>				
240, 260, not station wagon	DL, GL, 240	75-93	+	-

# WARNING

Installation of asm-autocontrol is only allowed to anchor point "C".

## Legend to Vehicle Reference List

**Heed all Indexes! - Symbols & #'s must be followed!**

- Retractor **must not** be installed to this anchor point.
- + Retractor can be installed to this anchor point without vehicle alteration.
- S** Stock seat not approved. For installation of retractor to this anchor point, use only special seats, tested and approved by SCHROTH.  
For SCHROTH tested and approved special seats see list below.
- Y** Installation of the retractor to anchor point "D" requires adapter (Part.-No.01103). Must be purchased in addition.

**Installation at anchor point "D": An approved seat (stock seat or special seat) required.**

- 10)** Index "S" do not refer to vehicles equipped with RECARO front seats ("sport seats").
- 12)** Special side belt [Part No. 0010X (X refers to webbing color)] for center lap belt installation **strictly** required. Must be purchased in addition.
- 15)** Installation of retractor to anchor point "E" instead of "D".
- 17)** Two adapters [Part No. 0015X (X refers to webbing color)] are **strictly** required and must be installed at **both** sides of the lap belt. Must be purchased in addition.
- 19)** Because of needed inner anchor point modification, installation kit (Part No. 00095) is **strictly** required. Must be purchased in addition.
- 27)** To avoid release of the pyrotechnic seat pretensioning devices the battery has to be disconnected 10 minutes before starting installation.
- 35)** If stock 3-point belt should be removed from the car **never** remove stock seat belt buckle as there is a safety device included (VW-description: lunar module) which **never** must be removed from the car.

**ADDITIONAL IMPORTANT INFORMATION CONTINUED ON BACK OF THIS SHEET**

For indexes see Legend to Vehicle Reference List.

# WARNING

If stock seats with integrated side airbags or seat-based sensors are being replaced by aftermarket seats care is necessary to ensure that the entire vehicle safety systems are not compromised. Elimination of seat based airbags sensors by swapping seats could result in a faulty deployment and/or non-function of airbags and permanent illumination of dashboard airbag system warning light. Buckle-pretensioners must never be removed from the vehicle with or without the seat without being secured against unintended firing. Removing buckle-pretensioners from the car also may disturb the function of other safety devices including the front airbags. Heed all instructions and information given in the vehicle's Owner Manual. Before changing seats, check with the vehicle manufacturer to see if your factory provided seats are so equipped, and if so, what provisions and precautions are necessary to preserve factory safety systems.

## List of Approved Special Seats

Be sure to contact your local Cobra, Corbeau, Flofit, König or Recaro dealer for information regarding seats recommended for the make, model and model year of your car.

### COBRA SUPAFORM

Cobra S, Instyle/LS, Montreaux

### CORBEAU EQUIPE

Avanti Recliner, GTB Recliner, GTS Recliner

### FLOFIT

Flofit-Sport

### KEIPER RECARO

Orthopäd (Orthopedic), Designer Touring (design touring), Idealsitz SR, L, LX, LS 84, CS 84, CSE, T-Line, Designer Sport (design sport), C-Classic, TX, N, LS, CT, Variomed, A 8

### KÖNIG

K330/370, K430/470, K530/570, K630/670, K730/770, K830/870, KS400/4000/700, CP400/4000/700, P700, RL200, CL200/400, RS/RSL 4400/8800

**For additional information or installation questions please contact our North American Importer:**

### MDI Inc.

3 First Avenue - Peabody, MA 01960  
Toll Free (888) 536-8550 / Phone (978) 532-1145  
Fax (978) 532-2016

**(800) 884-BELT**

guides you to your nearest dealer.

For indexes see Legend to Vehicle Reference List.

# DANGER

Before drilling make sure no lines, the fuel tank or the car body will be damaged.

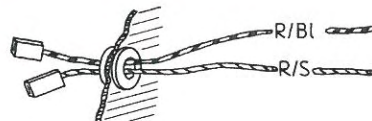

1. drill 15/32" (12 mm) hole
2. cut the cable grommet so you can pull it around both wires
3. run both plugs individually through the hole
4. push cable grommet into the hole to protect the wires against or being cut by sharp sheet metal edges

connection with the sensor

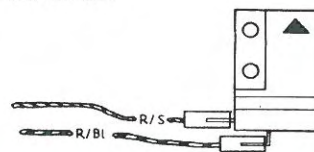

## SAFETY INSTRUCTIONS

- To remove the plug, pull the plastic cover backwards. The plug will release easily. Never pull on the wire to avoid any damage and separation from the plug.

### 7.3 Running the main wire (red/blue) to the current supply wire

Run the main wire (red/blue) to the dashboard or the fuse box so that it is covered by the floor carpet or the door sill cover. (See following illustration.)

The wire must not interfere with the foot pedals or with entry/exit to the vehicle and must not be exposed to damage by passenger movement. Also make sure that seat adjustment and movement is not restricted and the wire cannot be damaged by parts of the seat throughout the seat adjustment range (back and forth as well as up and down).

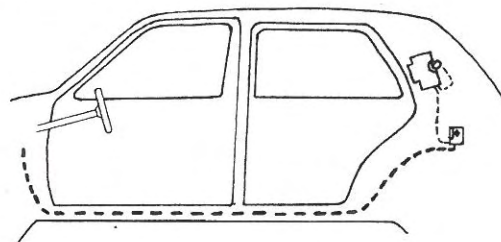

### 7.3.1 Current supply wire

## SAFETY INSTRUCTIONS

- The electrical current supply must be taken from a wire that does **not** carry current when the ignition is **turned off**. The wire selected must be "live" when the ignition is turned on, but before the engine starts. The flow of electrical current must not depend on the operation of any other electrical system or device.
- We recommend use of the wire feeding the rear window defogger, or any wire downstream from the fuse box running from any terminal marked no.15 (non German manufactured cars may use other symbols, numbers and/or letters). Do not connect to the wire that powers the computerized control system in the vehicle.

## WARNING

If the wiring for the harness belt system is connected to a wire which carries current even when the ignition is off, the electro-magnetic components of the harness belt system could draw current continuously and discharge your car's battery while parked.

Check the wiring diagram of your vehicle for a suitable lead, that can be easily used for proper installation as explained above. If in doubt, please see your car dealer.

If you install two SCHROTH asm-autocontrol harnessbelt systems in your car, you only have to connect the electrical system of the left (driver side) retractor directly to a current supply of the vehicle.

Be sure to follow the wiring instructions for the right (passenger side) retractor in paragraph 7.3.3 below.

### 7.3.2 Connecting

## WARNING

To prevent damage to your car's electrical system, only make the following connections when the ignition is turned off.

The fuse wire can be connected at any suitable position to the current supply wire (from terminal 15 at fuse box in cars of German manufacture) by the cable connector included.

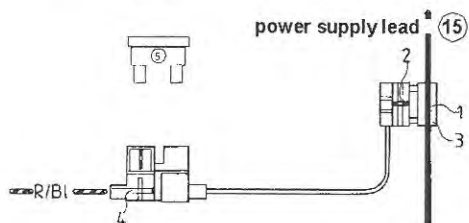

Do not remove any insulation from the wire!

1. Position power supply lead (from terminal 15 in cars of German manufacture) in groove (1) of cable connector.
2. Turn shackle (3) including the wire to position it onto the contacts (2).
3. Press the connector with pliers until the shackle (3) is engaged securely.

The power supply is now connected.

Now attach the main wire (red/blue) running from the sensor to the fuse holder.

Excess wire length may be cut off.

## WARNING

Make sure no wire is protruding into the passengers compartment.  
The operational safety of the foot controls must not be restricted!

Do not remove any insulation from the wire!

1. push the wire into the openings (4) of the fuse holder.
2. turn to close the shackle of the fuse holders and press it with pliers until it is engaged securely.
3. Plug the 5 Ampère fuse into the fuse holder.

The harness belt system will function after the ignition is turned on.

### 7.3.3 Wiring of a second SCHROTH asm-autocontrol harnessbelt system

As described in paragraph 7.3.1 (Current supply wire), it is not necessary to connect the fuse wire of the second SCHROTH asm-autocontrol harnessbelt system to the power supply lead at socket 15 in a vehicle of German manufacture or a similar socket in another car.

The connection must be made following the instructions in paragraph 7.3.2, but directly to the main wire (red/blue) of the first installed harness belt system between its fuse holder and sensor.

## WARNING

Never connect the fuse wire of the second harness belt system to the control wire of the first system!  
The interaction of both electromagnetic systems may severely damage other electronic systems of your vehicle.

Wiring diagram:

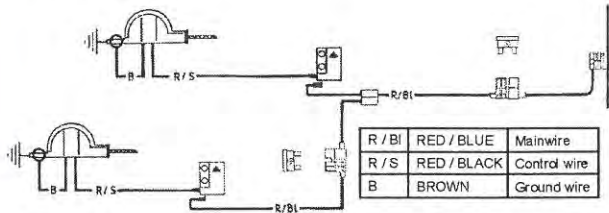

The fuse holder is equipped with a common blade type 5 Ampère. The fuse protects against discharging of the battery or fire in case of a short circuit.



## ! WARNING

**Use only 5 Ampère fuses!**

If a fuse blows first check the wiring and replace damaged wires with original spare parts (see page 37) before you insert a new fuse.

In order to help you quickly locate the cause of possible problems with the electrical system of the SCHROTH asm-autocontrol harnessbelts, we have prepared a Troubleshooting Diagram (see page 32). Please follow the specific diagram step by step if the retractor should not unlock when the ignition is turned on.

## OPERATING

### 1 General instructions

Most Countries require that seat belts be worn by all passengers when a car is in motion. Please check with your local authorities for further information! Regardless of the law in your State, it only makes sense to buckle up, so before you start your car, make sure that you and all of your passengers are properly restrained.

The SCHROTH asm harnessbelt system when properly installed and used according to applicable instructions can mitigate injury. Of course, the ability of any restraint system to mitigate or prevent injury is directly related to the type and severity of the accident.

The following pictures show the correct installation and use of SCHROTH asm harnessbelts for the specific vehicle depicted. This vehicle body is one of our test devices used to simulate head-on collisions at 31 mph. Doors and other components not required for the evaluation of harness belt performance have been removed.

## ! WARNING

This product is not designed and tested to be used with HANS® or other head and neck restraints e.g. Hutchens device.

Shoulder belts may slip off the HANS® and crotch straps e.g. of a Hutchens device cannot be properly attached to the lap belt. Malfunction can result in serious personal injuries or death.

## ! WARNING

Improper use of any seatbelt can cause serious personal injury or death.

To help reduce the risk of serious injury in an accident:

- Never strap more than one person in place, with each harness system.
- Never wear the harness system at the same time as the original equipment seat belts.
- Never use the lap belt portion of the harness system without the shoulder belts.
- Always make sure that lap belt and shoulder belts are not twisted when worn.
- Never use the harness belt system for children under the age of 12 years or to install an infant seat or child seat.
- Never use the harness belt system for persons who weigh less than 88 lbs or those who are less than 4'11" tall, regardless of age.
- Always wear the lap belt portion of the harness system low and tight across the pelvis. This is also recommended for the stock 3-point belt whenever it is worn.
- Never wear the belts over heavy clothing as it can interfere with proper positioning and adjustment of the belts, reducing the overall effectiveness of the system.
- Never wear the belts over rigid or breakable objects in or on your clothing, such as cell phones, eye glasses, pens, jewelry keys etc. as these may cause injury.
- Never allow lap or shoulder belts to rub against sharp objects.
- Never allow the belts to be damaged by becoming caught in door or seat hardware.

### 2 Adjustment of the seating position

Choose your most comfortable seating position for safe driving.

Driving and safety instructors recommend:

"Select your seating position in the vehicle so that you can fully grip the upper edge of the steering wheel with your elbow still slightly bent and without moving your upper body from the seatback. With the clutch (automatic transmission-brake) fully depressed your knee should still be slightly bent."

Remember: A "laid back" seating position might look 'cool', but does not contribute in any way to better or safer handling of your vehicle! No racing or rallye driver is "laid back" in his vehicle!

### 3 Routing of the shoulder belts

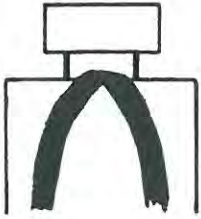

Distance between headrest guides min. 4¾" (120 mm).

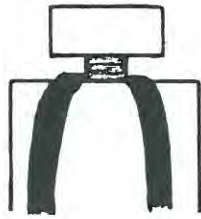

If there is only one headrest post or if the distance between 2 posts is less than 4¾" (120 mm).

## SAFETY INSTRUCTIONS

- For vehicles equipped with stock seats not suitable for use with harness belt systems, special seats are required. See Certified Vehicle List (Vehicle Reference List).

### 4 How to close and release the buckles

#### 4.1 Lap belt buckle

**To close:** Insert the latch into the buckle until you can hear a distinct clicking sound.

**To open:** Depressing the red button marked "PRESS" will open the buckle.

#### 4.2 Buckle between tail strap and shoulder belts (separation buckle).

**To close:** Insert the latch underneath the plastic cover until it locks in (1) and the plastic cover slides back into its normal position (2).

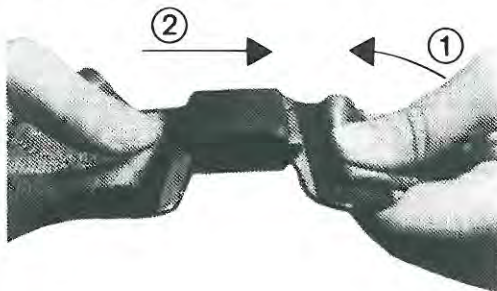

**To open:** Slide the plastic cover in the direction of the arrow to the stop (1). Tilt the latch downwards and remove it from the buckle (2).

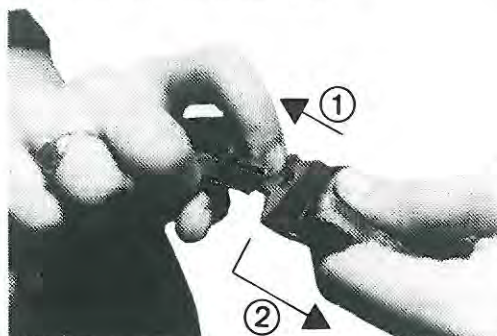

### 5 How to adjust the belt

#### 5.1 to lengthen the belt

Hold the adjuster at right angles - 90° - to the belt and pull in direction of the arrow (see illustration beside).

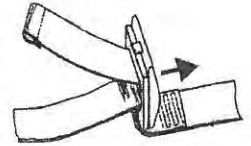

#### 5.2 to shorten the belt

Pull the end of the strap in direction of the arrow (see illustration beside).



SCHROTH offers accessory adjusting grips which can make the adjustment even more convenient (see page xx, Accessories).

### 6 Adjustment of the headrest and initial adjustment of the tail strap

#### 6.1 Retractor installed at anchor point "C"

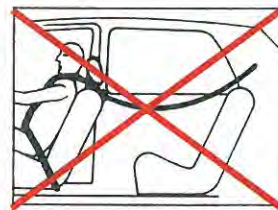

wrong way

The shoulder belts must not sag or be pulled downwards. Headrests must not restrict movement of the shoulder belts.

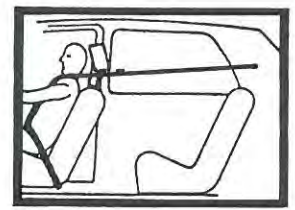

right way

The headrest is properly adjusted and the shoulder belts can move freely without slack.

#### 6.2 Retractor installed at anchor point "D" or "E"



wrong way

Belts must not have any sag.



wrong way

The tail strap must not be misdirected by upholsteries or the rear seat cushions.

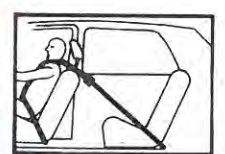

right way

The headrest is properly adjusted and the shoulder belts can move freely without slack.

- After choosing the correct seating position, put the belt on and adjust the lap belt so it fits tightly in the bend between the pelvic crest and the upper thigh. The release buckle should be located in the center in front of your body. If necessary, lengthen the tail strap first.
- Next adjust the shoulder belts: Make sure there is approx. 4 inches (10 cm) of loose belt protruding from each shoulder belt adjuster.
- One of the two shoulder belts should now be tight against the shoulder, the other shoulder belt should be looser.
- Tighten the looser shoulder belt until both shoulder belts



have the same pressure over the shoulders and in the chest area.

Make sure the shoulder straps are proper adjusted whenever the SCHROTH harnessbelt is worn.

For lap belt adjustment see following paragraph.

## 7 Putting on the belt

- a) First turn on the ignition to activate and release the retractor mechanism. **There is no need to start the engine!**

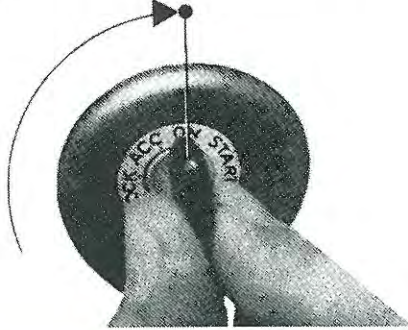

## SAFETY INSTRUCTIONS

- For your safety the retractor will lock at any time the ignition is turned off or whenever power to the retractor is interrupted.

- b) After choosing the correct seating position, put on the belt and adjust the lap belt so it fits tightly in the bend between the pelvic crest and the upper thigh. The release buckle should be located in the center in front of your body.



close buckle

tighten lap belt

WRONG

## ! WARNING

Improper fit of any lap belt can cause serious personal injury or death.

- **ALWAYS** make sure that the lap belt is tightly adjusted. A lap belt in a harness or 3-point system that is too loose will impair the performance of the system.
- The lap belt must fit tightly in the bend between the pelvic crest and the upper thigh!
- Make sure belt is properly adjusted when a different person uses the belt or each time the seat is readjusted. (Heed **WARNING** on adjuster.)

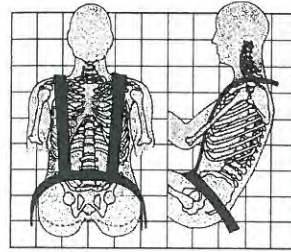

## SAFETY INSTRUCTIONS

- In order to get an even tighter fit of the lap belt, we recommend that you move your seat back a little, adjust the length of your belt as described above and move the seat forward to its normal position. This will help to tighten the lap belt even more. This recommendation does not apply when **both** attachment points of the lap belt are mounted directly to a seat on a sliding track and runner system, rather than one attached directly to the floor.

- b) Adjust the length of the inboard shoulder belt until both belts exert equal pressure against the upper torso.



equal pressure  
RIGHT

WRONG

## 8 Using of the rear seats

## ! WARNING

Never wear the SCHROTH harnessbelt if any rear seating position is occupied. Both front seat occupants must then use original equipment 3-point belts. The rear seat occupant could interact with the tail strap of the SCHROTH harnessbelt during an accident and cause serious injury to himself or to the wearer of the harness belt.



right way

wrong way

right way

# SAFETY INSTRUCTIONS

- As a constant reminder, the enclosed transparent sticker must be attached to the rear side window in a prominent place. The sticker cannot be removed without damage to chromate tinted glass. On such vehicles, you may affix the transparent sticker at a different, prominent location so that it will serve as a constant reminder.

## 9 Stowing the belts when not in use

If you use the stock 3-point belt instead of the SCHROTH harnessbelt, be sure to properly stow the harness belt. Buckle the lap belt in the space between the backrest and the seat. This prevents the belt from being pinched by the door, the seat tracks or backrest adjustment mechanism and also helps prevent the belt from being soiled. Open the separation buckle on the tail strap at harness belt system and stow the shoulder straps as well in the space between the backrest and the seat.

## CARE and MAINTENANCE

### 1 Inspection

Check the safety belt once a month for any damage. Cuts, tears and other damage to the belt will greatly reduce its effectiveness. Replace the belt or damaged parts immediately with original Spare Parts (see page 37, Spare Parts). Never use a damaged harness belt, use the standard 3-point belts which remain available for use.

Make sure the buckles are free of any obstruction and lock securely.

# WARNING

**Modified belts or such belts which have been re sewn are not strong enough and are dangerous in an accident. Never modify, disassemble or repair the belts yourself. For parts that can be replaced, use only original SCHROTH Spare Parts. Only original SCHROTH Accessories may be used with the harness belt system. Use of non-authorized parts and Accessories can reduce the effectiveness of the harness belt system.**

# SAFETY INSTRUCTIONS

- Any changes made to the belt will automatically void the warranty.

## 2 Troubleshooting

In the event problems arise which have been caused by incorrect installation or the vehicle's electrical system, we have prepared a Troubleshooting Diagram (see page 32), which will assist you in finding and eliminating the cause. Be sure to choose the specific diagram which describes your problem and carefully follow the instructions.

# WARNING

**Never use any restraint system that does not function properly. If questions arise, immediately contact your importer or the manufacturer!**

## 3 Maintenance of the retractor

If the retractor is very noisy when unreeling or retracting the tail strap or you note reduced tension at the tail strap, follow Program 1 in the Troubleshooting Diagram (see page 32).

# WARNING

**When removing and replacing the rubber cover be careful not to damage the wiring of the retractor.**

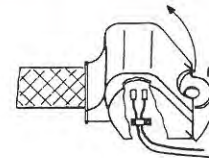

Turn the ignition on and pull the strap out completely. Turn the ignition off to lock the belt at full extension. Put one drop of a resin free oil (sewing machine oil) onto the bearing of the axle. Also put 2 or 3 drops through the hole of the plastic cover to the spring. Replace the rubber cover carefully.

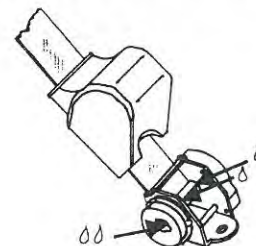

#### 4 Accident

## WARNING

A safety belt which was in use during an accident has been weakened and is unfit for further use and must be replaced!

## SAFETY INSTRUCTIONS

- One indication that the belt was exposed to excess strain and therefore requires replacement is when the stitches of the asm-system are ripped open and are protruding from underneath the asm-plastic cover.

## WARNING

A restitched asm seam is dangerous.  
The asm energy conversion device may not be restitched under any circumstances.

After an accident, in addition to replacing seat belt which were in use, also be sure to ask your car dealer for carefully check all seatbelt attachment points for deformation or cracks. Always make sure that the guidelines of the car manufacturer are followed if a repair is necessary.

#### 5 Cleaning

To clean the belt, use soap and warm water. Do not use any solvents! Do not dry the belt in the sun or near a radiator.

## WARNING

Improper cleaning or drying of the harness belts can weaken them, reduce their effectiveness and can result in serious personal injury or death.

SCHROTH reserves the right to incorporate any technical changes or further development in this product without notice.

If you need additional information or have any comments or questions about the SCHROTH asm harnessbelts, please contact your dealer or the importer.  
[see [www.schroth.com](http://www.schroth.com)]

In North America please contact:

### MDI Inc.

3 First Avenue  
Peabody, MA 01960  
Toll Free (888) 536-8550  
Phone (978) 532-1145  
Fax (978) 532-2016

Our Service Number  
**(800) 884-BELT**  
guides you to your nearest dealer.

### REMEMBER:

**For safety's sake, always buckle up.**

SCHROTH and SCHROTH-asm<sup>®</sup> are registered trademarks of SCHROTH Safety Products GmbH, Germany.

The SCHROTH-asm<sup>®</sup> safety system is patented in several European countries, the United States and Japan.

The copyrights of this Installation and Operating manual are property of SCHROTH Safety Products GmbH, Germany.

Copyright of this part or in hole, on paper, on film or electronically is allowed only after written permission by SCHROTH Safety Products GmbH, Germany.

© 2002, SCHROTH Safety Products GmbH, Arnsberg, Germany.

Printed in Germany

## TROUBLESHOOTING DIAGRAMS (TSD)

# SAFETY INSTRUCTIONS

- If you have a problem and do not know the cause, follow the specific Troubleshooting Diagram (TSD) step by step.
- If parts are required, use only original SCHROTH parts. They are designed especially for the harness belt system. Unauthorized parts can cause malfunction of the harness belt system or damage your vehicle.
- For your safety: Repairs to the retractor and sensor are strictly prohibited!
- If you cannot solve the problem after following the applicable Troubleshooting Diagram, contact your dealer or importer.

# WARNING

Never use the harness belt system if it does not function properly.  
Safe driving may be impossible and the effectiveness of the harness belt system will be impaired.

### TSD 1

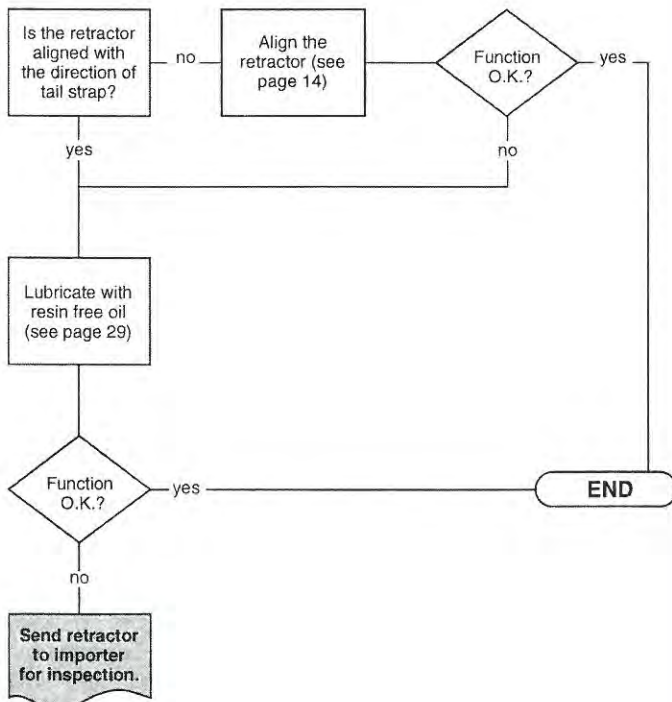

### TSD 2 Retractor does not lock during heavy braking.

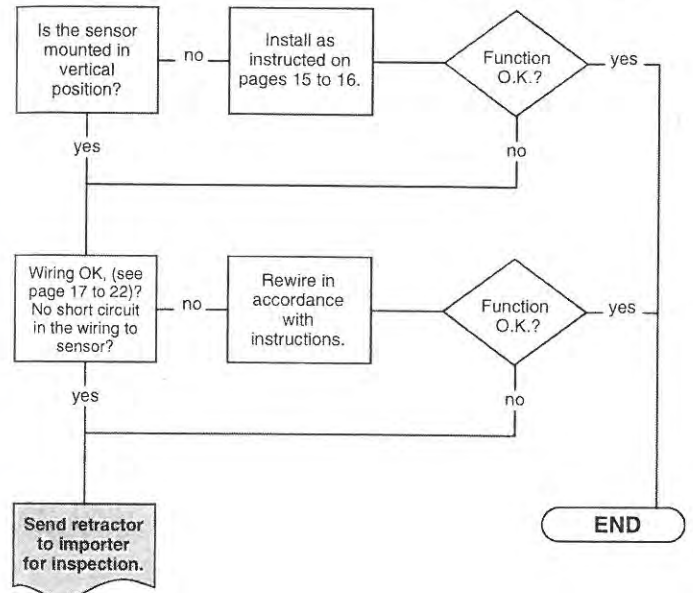

### TSD 3 Retractor does not lock when ignition is turned off.

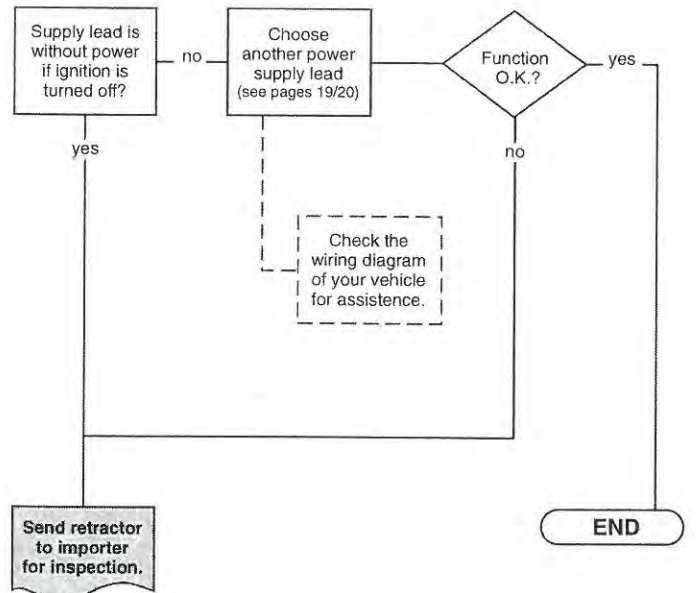

# SAFETY INSTRUCTIONS

- The retractor will not release if your car is more than 20 degrees out of horizontal position (steep hill, high curb).

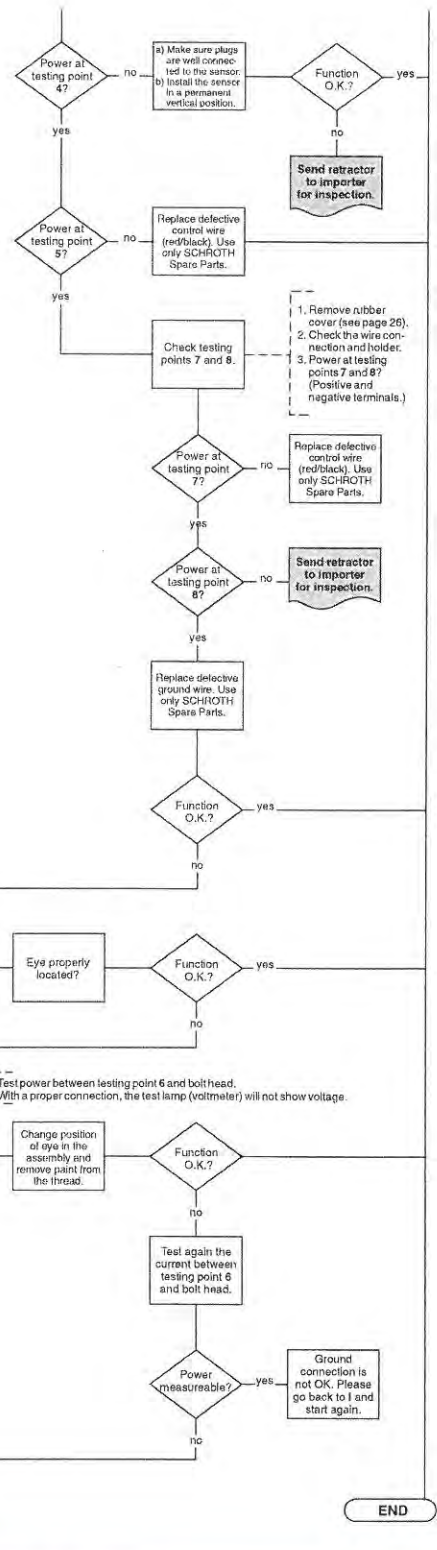
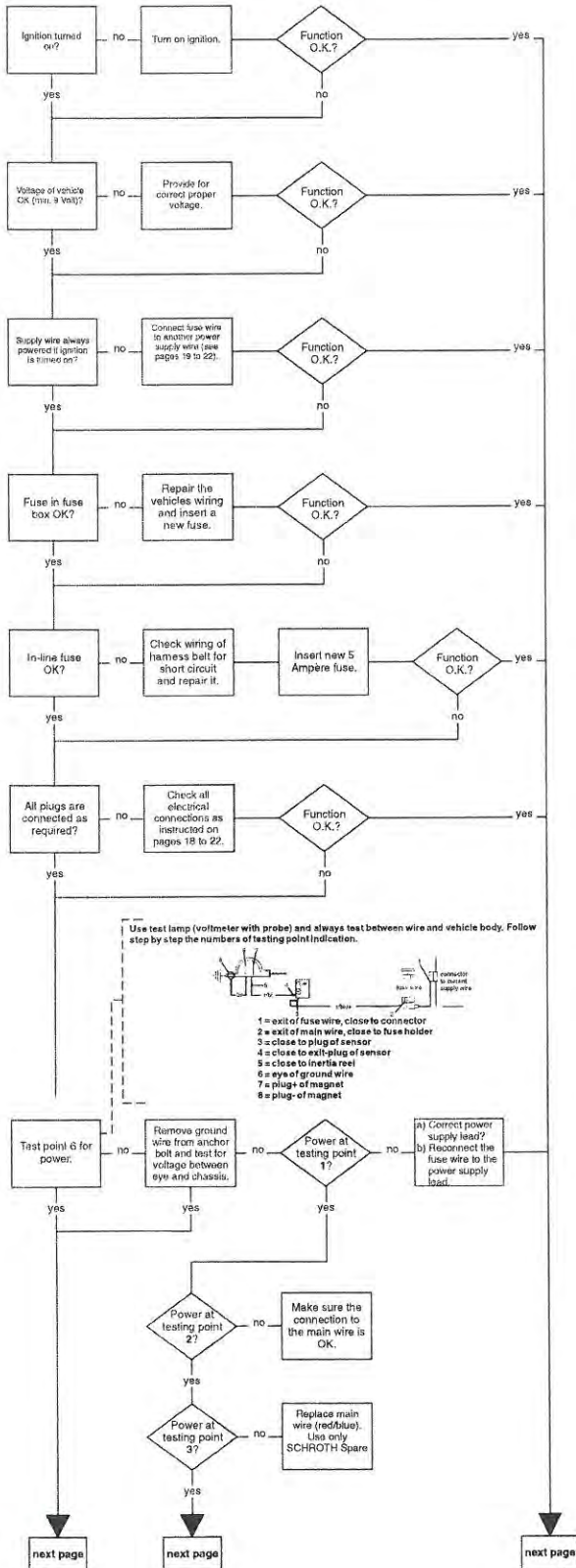

# SAFETY INSTRUCTIONS

- The recoil mechanism could remain permanently locked, if the tail strap is disconnected from the separation buckle while the ignition is off! The tail strap will be reeled in by the recoil mechanism. If the latch of the belt hits the cover without being slowed down, it might cause the recoil mechanism to permanently lock up.
- If you disconnect the belt from the separation buckle, make sure that the tail strap is slowly reeled in by manually slowing the retraction. This will prevent the above described effect.

**TSD 5** (Only use this instruction if all sources of malfunction have been eliminated according to TSD 4.)

The latch is touching the cover of the recoil mechanism. With the ignition on, the rear tail strap cannot be uncoiled.

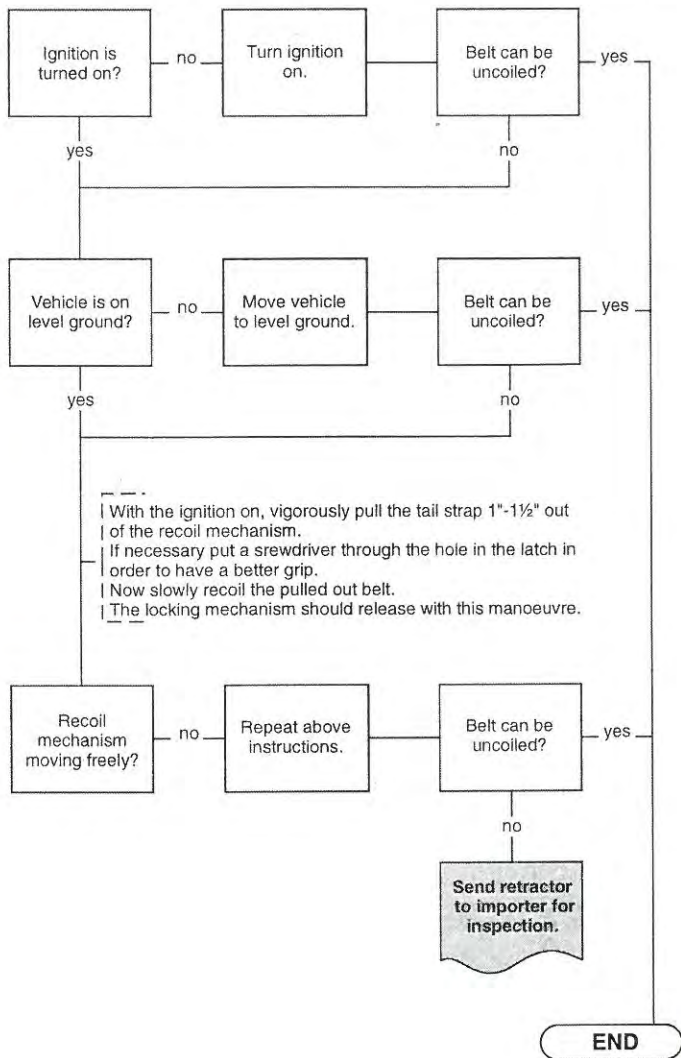

## INSTALLATION ACCESSORIES

**Color key:**

black=0, blue=1, red=2, yellow=3, purple=5, green=8

The X in PINs must be substituted by the color key of the color you want to order!

Shoulder belt pads, pair of	black with yellow flock printing	00109
Shoulder belt pads, pair of	blue with black flock printing	01109
	red, yellow, purple, green with black flock printing	0X109
Shoulder belt pads, pair of	black with grey flock printing	09109
Shoulder belt pads, pair of	silvergrey w. black flock printing	09209
Shoulder belt pads, pair of	black with black flock printing	09309
Adjusting grips for length adjuster, 4 pcs./package		00092
"Switch off" for manual lock of inertia reel		00096

## SPARE PARTS

Adapter for installation at anchor point "D"		01103
(refers to index Y) of Certified Vehicle List (Vehicle Reference List)		
Retractor with webbing	black	01170
	blue, red, yellow, purple, multicolor	0117X
Side belt	black	01120
	blue, red, yellow, purple, multicolor	0112X
Sensor including installation kit		01090
Wire kit including fuse		00098
Installation kit for harness belt		01097
(w/o Sensor incl. installation kit and wire kit incl. fuse)		
Cover for adjuster inclusive retainer		01084
Slide cover and spring for separation buckle		00087
Operating- and Installation Instructions		EA 4.3
Transparent interior sticker		W26ST

**SCHROTH®**

**SCHROTH®**